

↑ Place on fold
of fabric

↑

↑ Place on fold
of fabric

↑

Sewing Bag



Fold line (DO NOT CUT)



#4

Side Seams

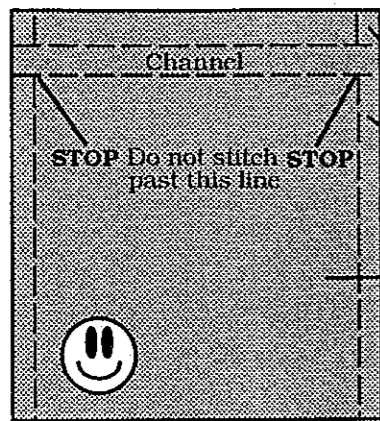

- A. **FOLD** bag in half.
 - B. **PIN** side edges of sewing bag.
 - C. **STITCH** side seams on top of side stitches.
- NOTE: Do NOT stitch inside the channel.

Fold of fabric

#5

Preparing Cord

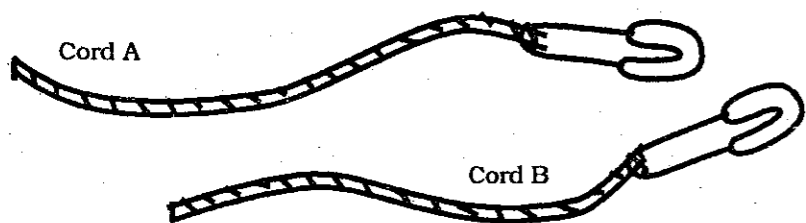

- A. **CUT** cord in two equal parts. We'll call one Cord A & the other Cord B.
- B. **ATTACH** a large safety pin to one end of each cord.

#6

Inserting Cord

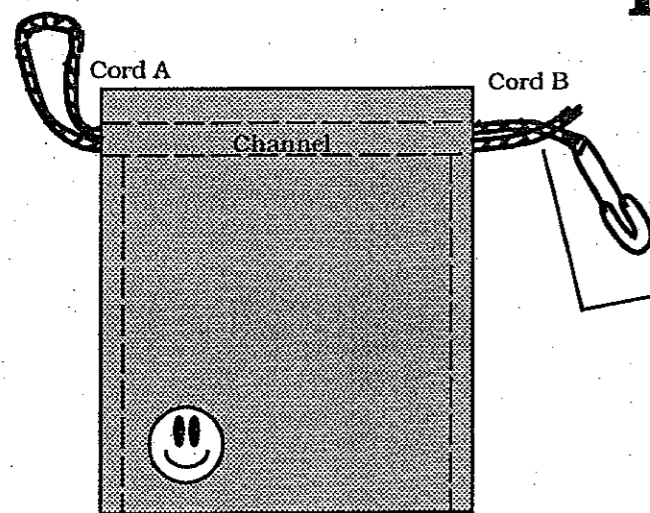

- A. **INSERT** safety pin with Cord A through one "Channel", continuing directly into the other "Channel".
- B. **TIE** the ends of Cord A together.
- C. **REPEAT** steps A & B by inserting cord B at the side of the bag opposite to cord A knot.

Fold of fabric

#7

Finishing Your Sewing Bag

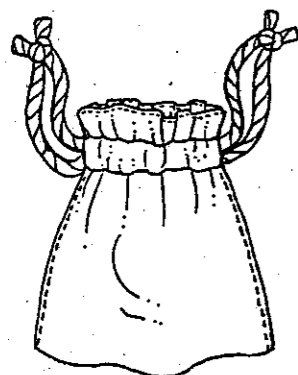

- A. **PRESS** your Sewing Bag.
- B. **CONGRATULATIONS** in completing your Sewing Bag.
- C. **COLOR** picture to match your Sewing Bag.
- D. **YOU** are now ready to select another pattern from this Packet.

15

Sewing Bag



#1

Cutting Out

45" (115 cm) and 60" (150 cm) wide fabric

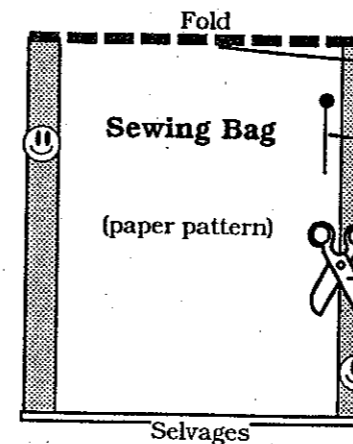

- A. **FOLD** fabric in half.
- B. **POSITION** paper pattern Straight of Grain FOLD LINE on fabric fold.
- C. **INSERT** pins in each pin picture, pinning through paper pattern and fabric.
- D. **CUT** on lines showing scissors. Cut through both paper pattern and fabric. Do not cut on Straight of Grain FOLD LINE.
- E. **REMOVE** all pins from paper pattern and fabric. Thread your sewing machine. You are ready to start sewing.

Selvages

#2

Raw Edges

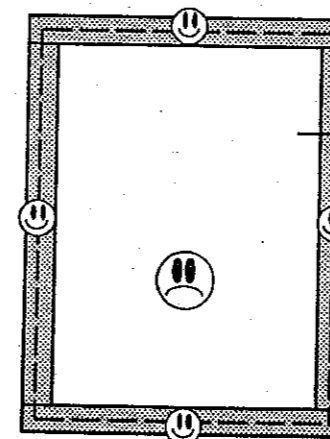

- A. **TURN** all raw edges 5/8 inch (1.5 cm) to ugly side of fabric and pin.
 - B. **STITCH** around all four edges. Remove pins as you sew.
- NOTE: Pivot at each corner.

#3

Chalk Talk Lines

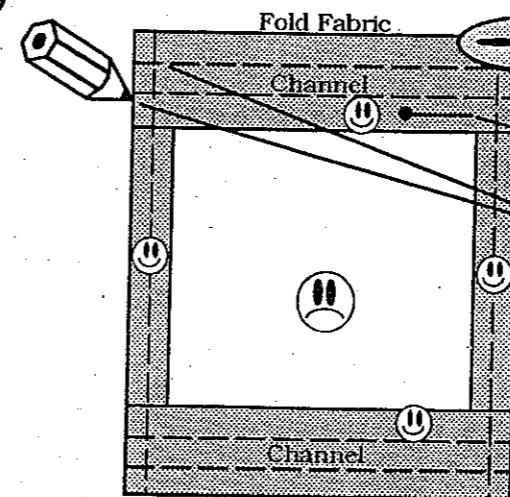

- A. **TURN** each short edge 3 inches (7.5 cm) to ugly side of fabric and pin, then press.
- B. **"CHALK TALK"** two lines 1 1/4 inches wide (3.2 cm) in the center of each folded edge. NOTE: This is called a "Channel".
- C. **STITCH** on all four "Chalk Talk" lines.

Fold Fabric

14